

# PRODUCT CATALOGUE





# TABLE OF CONTENTS

## GENERAL INFORMATION

PIMMS GROUP	5
TEGO PLASTICS	11

## AGRICULTURAL

2-WAY BIN SOLID WITH FEET	14
2-WAY BIN 8MM WITH FEET	14
4-WAY BIN 8MM WITH FEET	15
2-WAY BIN 3MM WITH FEET	15
AGRI CRATE, RECYCLED, VENTED BASE	16
AGRI CRATE, RECYCLED, SOLID BASE	16
AGRI CRATE, VIRGIN, VENTED BASE	16
AGRI CRATE, VIRGIN, SOLID BASE	17
REUSABLE PLASTIC CRATE 400X300X180	18
REUSABLE PLASTIC CRATE 600X400X120	19
REUSABLE PLASTIC CRATE 600X400X180	20
REUSABLE PLASTIC CRATE 600X400X230	21
MANGO DRIP TRAY	22
242 CELL VEGETABLE PROPAGATION TRAY	22

## RETAIL

SUPER DOLLY	26
PICKING TOTE	26
NESTABLE TOTE BINS 7L	26
NESTABLE TOTE BINS 18L	27
NESTABLE TOTE BINS 52L	27
NESTABLE TOTE BINS 68L	27

## STANTON GLOBAL

SAFELOAD	31
7TWENTY	33
PALLCHEM	35



## ***Engineered Plastics. Trusted Partnerships. Proven Performance.***

PIMMS Group is a South African plastics manufacturing company specialising in custom injection moulding, rigid packaging and engineered plastic solutions for diverse industrial, agricultural and commercial markets.

Established in 2001, the Group has grown into a multi-site manufacturing business with operations in Johannesburg and Cape Town, supported by strong technical expertise, modern production capabilities and long-standing customer partnerships. Our facilities are equipped to handle projects ranging from specialised technical components to large-volume production, ensuring consistency, reliability and efficiency at every stage.

Alongside our sister company, Stanton Global, which focuses on product design, development and innovation, PIMMS Group delivers complete solutions from concept to production. This integrated approach enables us to support customers through design, tooling, manufacturing, finishing and final delivery, ensuring a seamless product development journey.

### **Our Manufacturing Footprint**

#### **Johannesburg** - *Laser Park, Honeydew*

Head office and primary injection moulding facility delivering custom components, specialised moulding solutions and manufacturing support.

#### **Cape Town** - *Brackenfell*

Focused on rigid packaging, agricultural containers and custom injection moulding for local and export markets.

#### **Tego Plastics** - *A PIMMS Group Brand*

Specialising in durable agricultural bins, crates and rigid packaging solutions designed for demanding environments and efficient logistics.

### **What We Do**

PIMMS Group provides integrated plastics manufacturing solutions including:

- Custom injection moulding
- Product design collaboration
- Tooling and mould management
- Rigid packaging production
- Cleanroom and specialised moulding
- Secondary operations and assembly

Our approach combines technical capability, manufacturing experience and responsive service to ensure reliable, high-quality outcomes.

## Our Focus Areas

### Customer Partnership

We build long-term relationships by understanding customer needs, delivering consistent quality, and providing practical solutions that add real value.

### Our People

Our success is driven by skilled teams, continuous development, and a culture focused on collaboration, accountability and pride in our work.

### Responsible Manufacturing

We prioritise sustainable practices, durable product design, responsible material use and compliance with environmental and safety standards.

### Growth Through Innovation

Investment in technology, product development and strategic partnerships ensures we remain adaptable and ready for future market demands.





## Industries We Support

Our products and solutions serve a wide range of sectors:

- Agriculture and rigid packaging
- Telecommunications and infrastructure
- Logistics and transport
- Pharmaceutical and consumer packaging
- Industrial and manufacturing sectors

We combine design expertise, manufacturing precision and industry insight to deliver solutions that perform reliably in demanding environments.

## Looking Ahead

PIMMS Group continues to expand its capabilities, strengthen partnerships and develop innovative solutions that support customer success. With a strong manufacturing foundation, a commitment to quality, and a forward-looking approach, we remain focused on delivering dependable plastic solutions today and into the future.



## Our Services

At PIMMS Group, we offer comprehensive plastics manufacturing solutions supported by advanced injection moulding technology, experienced technical teams and world-class production facilities. From precision plastic components to high-volume rigid packaging, our services are designed to deliver consistent quality, reliability and efficiency across diverse industries.

Our core services include:

- Custom injection moulding solutions
- Product design collaboration and development support
- Tooling design, sourcing and mould management
- Rigid packaging manufacturing
- Cleanroom and specialised moulding applications
- Secondary operations, finishing and assembly





## Value-Added Services

Beyond manufacturing, we provide value-added finishing services that complete the product journey. These include laser printing and screen printing for branding, traceability and product identification, ensuring durable, professional results that enhance both functionality and presentation.

Our approach combines technical expertise, manufacturing experience and responsive service, allowing us to partner closely with customers to deliver solutions tailored to their exact requirements.

*We Care for People by Making Excellent Products*

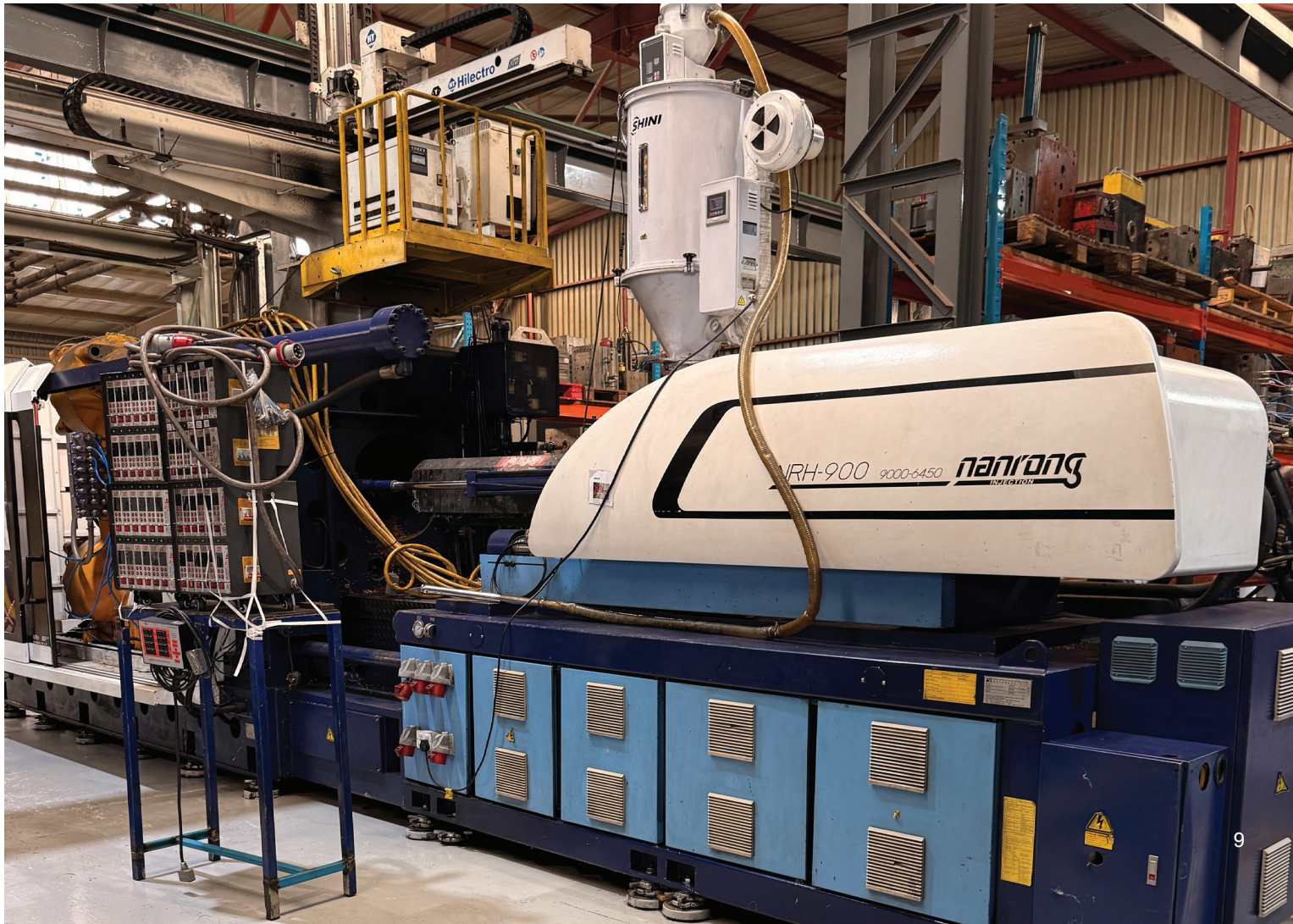



## ***RIGID PACKAGING THAT WORKS AS HARD AS YOU DO***

At Tego Plastics, we manufacture rigid packaging designed for real working environments; farms, packhouses, distribution centres, and retail floors. Our collapsible crates, tote bins, mango drip trays and other agricultural packaging solutions are built for durability, hygiene, and efficiency. These aren't just containers. They are tools that protect your product, improve handling, and perform consistently through demanding supply chains.

### **Built for Agriculture. Proven in Retail.**

Fresh produce moves fast. It gets stacked, washed, transported, stored and displayed, often multiple times in a single day. Our rigid packaging is engineered to handle that reality.

- Collapsible crates that maximise return logistics and reduce transport costs
- Tote bins designed for strength, stability and repeated use
- Mango drip trays that protect fruit quality and reduce waste
- A range of rigid packaging solutions suited to both agricultural and retail environments

### **Why Buy from Tego?**

#### **Quality That Protects Your Product**

Your packaging should never be the weak link. Our products are designed for structural integrity, consistent dimensions, and long-term durability. They withstand load, temperature changes, and repeated handling because downtime and breakages cost you money.

#### **Designed for Real Supply Chains**

We understand agricultural cycles, export requirements, cold storage, and retail display conditions. Our packaging solutions are practical, stackable, easy to clean, and compatible with modern logistics systems.

#### **Purpose-Driven Excellence**

We care for people by making excellent products. That means:

- Protecting the farmers who rely on consistent packaging
- Supporting packhouses that need efficiency
- Reducing waste through durable, reusable solutions
- Helping retailers present quality produce safely and attractively

Excellence is not a slogan - it's a daily standard.

#### **Continuous Improvement**

Markets change. Crops change. Regulations change. We are committed to refining and improving our products where necessary to meet evolving industry demands. If there's a better way to strengthen, simplify, or enhance performance, we pursue it.





**TEGO**  
P L A S T I C S

# AGRICULTURAL

## TEGO BULK BINS

- 2-WAY BIN SOLID WITH FEET
- 2-WAY BIN 8MM WITH FEET
- 4-WAY BIN 8MM WITH FEET
- 2-WAY BIN 3MM WITH FEET

## TEGO STORAGE CRATE

- AGRI CRATE, RECYCLED, VENTED BASE
- AGRI CRATE, RECYCLED, SOLID BASE
- AGRI CRATE, VIRGIN, VENTED BASE
- AGRI CRATE, VIRGIN, SOLID BASE

## REUSABLE PLASTIC CRATE

- 400X300X180
- 600X400X120
- 600X400X180
- 600X400X230

## AGRI TRAYS

- MANGO DRIP TRAY
- 242 CELL VEGETABLE PROPAGATION TRAY

# AGRICULTURAL TEGO BULK BINS

## 2-WAY BIN SOLID WITH FEET

<b>WEIGHT WITH FEET</b>	38kgs
<b>LENGTH</b>	1275mm
<b>WIDTH</b>	1080mm
<b>HEIGHT</b>	750mm
<b>CAPACITY</b>	781L
<b>MATERIAL</b>	Polypropylene
<b>DRENCHING SLOTS</b>	None
<b>GAP WHEN NESTING</b>	15mm
<b>UV LIFESPAN</b>	10-year
<b>COMPOSITION</b>	Recycled OR Virgin
<b>COLOUR</b>	Customisable



### FEATURES & BENEFITS

- Maximum volume capacity for efficient packing and transport
- Smooth internal surfaces reduce bruising and product damage
- Lightweight compared to wooden bins, reducing handling and logistical costs
- 2-Way forklift and pallet-jack entry suitable for controlled handling environments
- The feet to withstand heavy-duty impact minimising replacement costs
- Fully recyclable and supported by a bin return programme for circular reprocessing

## 2-WAY BIN 8MM WITH FEET

<b>WEIGHT</b>	37kgs
<b>LENGTH</b>	1275mm
<b>WIDTH</b>	1080mm
<b>HEIGHT</b>	750mm
<b>CAPACITY</b>	781L
<b>MATERIAL</b>	Polypropylene
<b>DRENCHING SLOTS</b>	8mm
<b>GAP WHEN NESTING</b>	15mm
<b>UV LIFESPAN</b>	10-year
<b>COMPOSITION</b>	Recycled OR Virgin
<b>COLOUR</b>	Customisable



### FEATURES & BENEFITS

- 2-Way entry for efficient handling in packhouses
- High-volume design with 8mm ventilation slots for optimal airflow and faster cooling
- Enhanced drenching slots prevents water accumulation while keeping debris out, ensuring longer preservation of the produce
- Lightweight and easy to handle, reducing transport and logistics costs
- Smooth internal surfaces protect produce from bruising and produce preservation
- Impact-resistant feet with drainage pockets, which reduce replacement costs
- Fully recyclable and supported by a bin return programme for circular reprocessing

# AGRICULTURAL TEGO BULK BINS

## FEATURES & BENEFITS

- 8mm ventilation slots provide optimal airflow and faster cooling of produce
- 4-Way entry allows maximum flexibility for forklifts and pallet jacks
- Smooth internal walls reduce bruising, ideal for export-quality stone and pome fruits
- Precision design for optimal nesting, stacking and storage
- Bins designed to collide safely without wall bulging which prevents bruising on the produce
- The feet are designed to withstand high impact levels which reduces replacement costs
- Fully recyclable and supported by a bin return programme for circular reprocessing



## 4-WAY BIN 8MM WITH FEET

<b>WEIGHT</b>	37kgs
<b>LENGTH</b>	1280mm
<b>WIDTH</b>	1080mm
<b>HEIGHT</b>	750mm
<b>CAPACITY</b>	731L
<b>MATERIAL</b>	Polypropylene
<b>DRENCHING SLOTS</b>	8mm
<b>GAP WHEN NESTING</b>	40mm
<b>UV LIFESPAN</b>	10-year
<b>COMPOSITION</b>	Recycled OR Virgin
<b>COLOUR</b>	Customisable

## FEATURES & BENEFITS

- 2-Way entry for flexible handling in less congested supply chains
- High-capacity design with 3mm ventilation slots for controlled airflow and cooling
- Smooth interior walls reduce fruit bruising and product damage
- Optimised drenching slots facilitate efficient water removal and prevent debris entering the bin, thus ensuring longer preservation of the produce
- Lightweight construction reduces handling and transport costs
- Strong, durable feet designed for repeated high-impact use
- Fully recyclable and supported by a bin return programme for circular reprocessing



## 2-WAY BIN 3MM WITH FEET

<b>WEIGHT</b>	37kgs
<b>LENGTH</b>	1275mm
<b>WIDTH</b>	1080mm
<b>HEIGHT</b>	750mm
<b>CAPACITY</b>	781L
<b>MATERIAL</b>	Polypropylene
<b>DRENCHING SLOTS</b>	3mm
<b>GAP WHEN NESTING</b>	15mm
<b>UV LIFESPAN</b>	10-year
<b>COMPOSITION</b>	Recycled OR Virgin
<b>COLOUR</b>	Customisable

# TEGO STORAGE CRATES

## AGRI CRATE, RECYCLED PLASTIC, VENTED BASE

<b>WEIGHT</b>	1.8kgs
<b>LENGTH</b>	526mm
<b>WIDTH</b>	348mm
<b>HEIGHT</b>	290mm
<b>MATERIAL</b>	Polypropylene
<b>DRENCHING SLOTS</b>	Yes
<b>COLOUR</b>	Customisable



### FEATURES & BENEFITS

- Robust and lightweight for use efficient picking and handling
- Vented base ensures optimal airflow, cooling and water drainage
- Smooth internal surfaces minimise bruising and product damage
- Reinforced centre support prevents warping under heavy loads
- Fully recyclable with crate return policy for circular reprocessing

## AGRI CRATE, RECYCLED PLASTIC, SOLID BASE

<b>WEIGHT</b>	1.8kgs
<b>LENGTH</b>	526mm
<b>WIDTH</b>	348mm
<b>HEIGHT</b>	290mm
<b>MATERIAL</b>	Polypropylene
<b>DRENCHING SLOTS</b>	Yes
<b>COLOUR</b>	Customisable



### FEATURES & BENEFITS

- Strong, robust design withstands field, orchard, and transport conditions
- Solid base protects produce from dirt, moisture and contamination
- Smooth interior reduces bruising and damage during handling
- Lightweight compared to wooden crates, lowering transport costs
- Fully recyclable and supported by a crate return programme

## AGRI CRATE, VIRGIN PLASTIC, VENTED BASE

<b>WEIGHT</b>	1.8kgs
<b>LENGTH</b>	526mm
<b>WIDTH</b>	348mm
<b>HEIGHT</b>	290mm
<b>MATERIAL</b>	Polypropylene
<b>DRENCHING SLOTS</b>	Yes
<b>COLOUR</b>	Customisable



### FEATURES & BENEFITS

- Robust and lightweight for use efficient picking and handling
- Vented base ensures optimal airflow, cooling and water drainage
- Smooth internal surfaces minimise bruising and product damage
- Reinforced centre support prevents warping under heavy loads
- Fully recyclable with crate return policy for circular reprocessing

# AGRICULTURAL TEGO STORAGE CRATES

## FEATURES & BENEFITS

- Strong, robust design withstands field, orchard, and transport conditions
- Solid base protects produce from dirt, moisture and contamination
- Smooth interior reduces bruising and damage during handling
- Lightweight compared to wooden crates, lowering transport costs
- Fully recyclable and supported by a crate return programme



## AGRI CRATE, VIRGIN PLASTIC, SOLID BASE

<b>WEIGHT</b>	1.8kgs
<b>LENGTH</b>	526mm
<b>WIDTH</b>	348mm
<b>HEIGHT</b>	290mm
<b>MATERIAL</b>	Polypropylene
<b>DRENCHING SLOTS</b>	Yes
<b>COLOUR</b>	Customisable

# AGRICULTURAL REUSABLE PLASTIC CRATES

## 400X300X180

<b>LENGTH</b> <small>(EXTERNAL)</small>	400mm
<b>WIDTH</b> <small>(EXTERNAL)</small>	300mm
<b>HEIGHT</b> <small>(EXTERNAL)</small>	180mm
<b>LENGTH</b> <small>(INTERNAL)</small>	370mm
<b>WIDTH</b> <small>(INTERNAL)</small>	270mm
<b>HEIGHT</b> <small>(INTERNAL USABLE)</small>	156.5mm
<b>INCREMENTAL STACK HEIGHT</b>	170.7mm
<b>NET WEIGHT</b>	1.14kg
<b>WEIGHT TOLERANCE</b>	+/-5%
<b>USABLE VOLUME</b>	16L
<b>INDIVIDUAL LOAD CAPACITY</b>	12kg
<b>MAX STATIC LOAD</b>	250kg
<b>MAX DYNAMIC LOAD</b>	250kg
<b>MATERIAL</b>	Polypropylene
<b>OPERATIONAL TEMPERATURE RANGE</b>	-20°C to 40°C
<b>BASE TYPE</b>	Ventilated
<b>LONG SIDE WALL TYPE</b>	Ventilated
<b>SHORT SIDE WALL TYPE</b>	Ventilated
<b>HANDGRIP LONG-SIDE</b>	Open
<b>HANDGRIP SHORT-SIDE</b>	Open
<b>VARIOUS COLOUR</b>	Depending on MOQ's

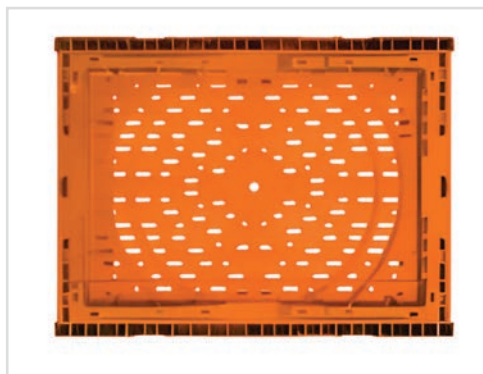
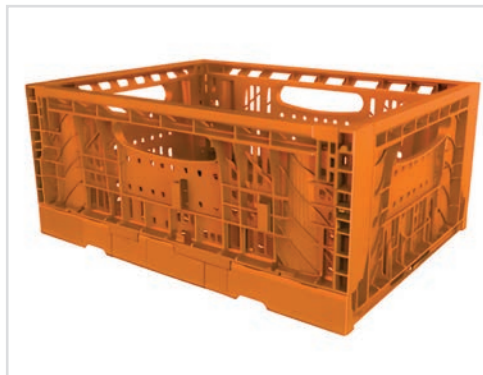

### FEATURES & BENEFITS

- These Foldable Small Crates are 100% locally produced
- Can be manufactured in the major centers
- Rent-to-Own options available
- Manufactured with Food Grade approved materials, so suitable for use with Foods
- Smooth inner surfaces for maximum content protection
- No need to worry about produce spoiling even during long-distance transportation
- The perforated sides ensure excellent drainage of water and maximized ventilation enables quick cooling to maintain the quality and freshness of produce and minimize losses throughout the Field to Fork cold-chain process
- The smooth inner surface walls and a minimum of outside recesses, makes the RPC's easy to wash and clean
- This leads to savings on energy and water consumption through the cleaning and drying of the RPC throughout its life cycle
- The RPC is also compatible with most automatic cleaning and drying equipment available on the market
- Equipped with four ergonomic hand holes, making them easy to carry and handle during manual or automated processes
- 80% folding ratio and only 36mm high when folded, reducing storage space and cutting down return logistics costs
- Environmentally friendly and 100% recyclable at the end of its long service life, promoting sustainability and eco-friendliness

# AGRICULTURAL REUSABLE PLASTIC CRATES

## FEATURES & BENEFITS

- These Foldable Small Crates are 100% locally produced
- Can be manufactured in the major centers
- Rent-to-Own options available
- Manufactured with Food Grade approved materials, so suitable for use with Foods
- Smooth inner surfaces for maximum content protection
- No need to worry about produce spoiling even during long-distance transportation
- The perforated sides ensure excellent drainage of water and maximized ventilation enables quick cooling to maintain the quality and freshness of produce and minimize losses throughout the Field to Fork cold-chain process
- The smooth inner surface walls and a minimum of outside recesses, makes the RPC's easy to wash and clean
- This leads to savings on energy and water consumption through the cleaning and drying of the RPC throughout its life cycle
- The RPC is also compatible with most automatic cleaning and drying equipment available on the market
- Equipped with four ergonomic hand holes, making them easy to carry and handle during manual or automated processes
- 80% folding ratio and only 36mm height when folded, reducing storage space and cutting down return logistics costs
- Environmentally friendly and 100% recyclable at the end of its long service life, promoting sustainability and eco-friendliness



## 600X400X120

<b>LENGTH</b> (EXTERNAL)	600mm
<b>WIDTH</b> (EXTERNAL)	400mm
<b>HEIGHT</b> (EXTERNAL)	120mm
<b>LENGTH</b> (INTERNAL)	570mm
<b>WIDTH</b> (INTERNAL)	370mm
<b>HEIGHT</b> (INTERNAL USABLE)	165mm
<b>NET WEIGHT</b>	1.47kg
<b>WEIGHT TOLERANCE</b>	+/-5%
<b>USABLE VOLUME</b>	35L
<b>MATERIAL</b>	Polypropylene
<b>OPERATIONAL TEMPERATURE RANGE</b>	-10°C to 40°C
<b>BASE TYPE</b>	Ventilated
<b>LONG SIDE WALL TYPE</b>	Ventilated
<b>SHORT SIDE WALL TYPE</b>	Ventilated
<b>HANDGRIP LONG-SIDE</b>	Open
<b>HANDGRIP SHORT-SIDE</b>	Open
<b>VARIOUS COLOURS</b>	Depending on MOQ's

# REUSABLE PLASTIC CRATES

## 600X400X180

<b>LENGTH</b> <small>(EXTERNAL)</small>	600mm
<b>WIDTH</b> <small>(EXTERNAL)</small>	400mm
<b>HEIGHT</b> <small>(EXTERNAL)</small>	180mm
<b>LENGTH</b> <small>(INTERNAL)</small>	570mm
<b>WIDTH</b> <small>(INTERNAL)</small>	370mm
<b>HEIGHT</b> <small>(INTERNAL USABLE)</small>	157mm
<b>INCREMENTAL STACK HEIGHT</b>	171mm
<b>NET WEIGHT</b>	1.83kg
<b>WEIGHT TOLERANCE</b>	+/-5%
<b>USABLE VOLUME</b>	33L
<b>INDIVIDUAL LOAD CAPACITY</b>	15kg
<b>MAX STATIC LOAD</b>	250kg
<b>MAX DYNAMIC LOAD</b>	250kg
<b>MATERIAL</b>	Polypropylene
<b>OPERATIONAL TEMPERATURE RANGE</b>	-20°C to 40°C
<b>BASE TYPE</b>	Ventilated
<b>LONG SIDE WALL TYPE</b>	Ventilated
<b>SHORT SIDE WALL TYPE</b>	Ventilated
<b>HANDGRIP LONG-SIDE</b>	Open
<b>HANDGRIP SHORT-SIDE</b>	Open
<b>VARIOUS COLOURS</b>	Depending on MOQ's

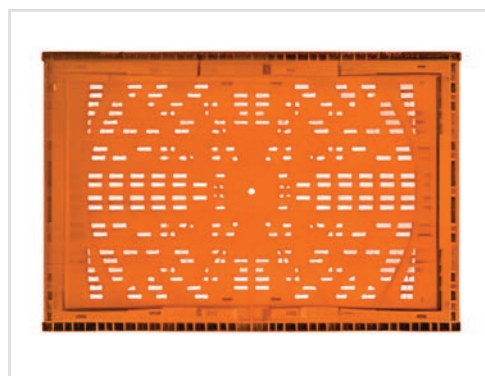

### FEATURES & BENEFITS

- These Foldable Small Crates are 100% locally produced
- Can be manufactured in the major centers
- Rent-to-Own options available
- Manufactured with Food Grade approved materials, so suitable for use with Foods
- Smooth inner surfaces for maximum content protection
- No need to worry about produce spoiling even during long-distance transportation
- The perforated sides ensure excellent drainage of water and maximized ventilation enables quick cooling to maintain the quality and freshness of produce and minimize losses throughout the Field to Fork cold-chain process
- The smooth inner surface walls and a minimum of outside recesses, makes the RPC's easy to wash and clean
- This leads to savings on energy and water consumption through the cleaning and drying of the RPC throughout its life cycle
- The RPC is also compatible with most automatic cleaning and drying equipment available on the market
- Equipped with four ergonomic hand holes, making them easy to carry and handle during manual or automated processes
- 80% folding ratio and only 36mm high when folded, reducing storage space and cutting down return logistics costs
- Environmentally friendly and 100% recyclable at the end of its long service life, promoting sustainability and eco-friendliness

# AGRICULTURAL REUSABLE PLASTIC CRATES

## FEATURES & BENEFITS

- These Foldable Small Crates are 100% locally produced
- Can be manufactured in the major centers
- Rent-to-Own options available
- Manufactured with Food Grade approved materials, so suitable for use with Foods
- Smooth inner surfaces for maximum content protection.
- No need to worry about produce spoiling even during long-distance transportation
- The perforated sides ensure excellent drainage of water and maximized ventilation enables quick cooling to maintain the quality and freshness of produce and minimize losses throughout the Field to Fork cold-chain process
- The smooth inner surface walls and a minimum of outside recesses, makes the RPC's easy to wash and clean
- This leads to savings on energy and water consumption through the cleaning and drying of the RPC throughout its life cycle
- The RPC is also compatible with most automatic cleaning and drying equipment available on the market
- Equipped with four ergonomic hand holes, making them easy to carry and handle during manual or automated processes
- 80% folding ratio and only 36mm height when folded, reducing storage space and cutting down return logistics costs
- Environmentally friendly and 100% recyclable at the end of its long service life, promoting sustainability and eco-friendliness

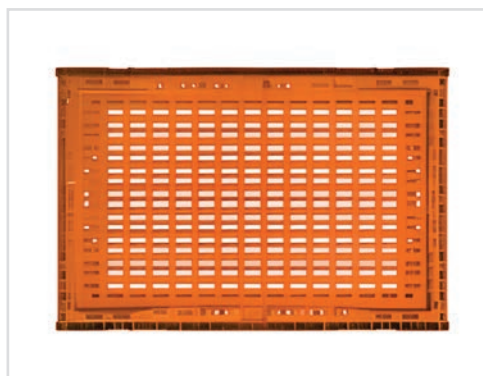

## 600X400X230

<b>LENGTH</b> (EXTERNAL)	600mm
<b>WIDTH</b> (EXTERNAL)	400mm
<b>HEIGHT</b> (EXTERNAL)	230mm
<b>LENGTH</b> (INTERNAL)	570mm
<b>WIDTH</b> (INTERNAL)	370mm
<b>HEIGHT</b> (INTERNAL USABLE)	207mm
<b>NET WEIGHT</b>	1.9kg
<b>WEIGHT TOLERANCE</b>	+/-5%
<b>INDIVIDUAL LOAD CAPACITY</b>	15kg
<b>MAX STATIC LOAD</b>	250kg
<b>MAX DYNAMIC LOAD</b>	250kg
<b>MATERIAL</b>	Polypropylene
<b>OPERATIONAL TEMPERATURE RANGE</b>	-10°C to 40°C
<b>BASE TYPE</b>	Ventilated
<b>LONG SIDE WALL TYPE</b>	Ventilated
<b>SHORT SIDE WALL TYPE</b>	Ventilated
<b>HANDGRIP LONG-SIDE</b>	Open
<b>HANDGRIP SHORT-SIDE</b>	Open
<b>VARIOUS COLOURS</b>	Depending on MOQ's

# AGRICULTURAL AGRI TRAYS

## MANGO DRIP TRAY

<b>WEIGHT</b>	740grams
<b>LENGTH</b>	598mm
<b>WIDTH</b>	400mm
<b>HEIGHT</b>	58mm
<b>CAPACITY</b>	1 tray holds 24 mangoes
<b>MATERIAL</b>	Polypropylene
<b>UV LIFESPAN</b>	5+ years
<b>COMPOSITION</b>	Virgin PP
<b>COLOUR</b>	Red & Orange (Customisable on request)



### FEATURES & BENEFITS

- Designed to support efficient harvesting and improved fruit quality, our Mango Drip Tray provides a practical solution for modern mango farming operations.
- Engineered for durability and ease of use, it helps optimise handling processes while reducing potential fruit damage.
- Helps minimise fruit bruising and damage during harvesting
- Supports improved fruit quality and reduced wastage
- Durable, farm-ready design built for demanding conditions
- Lightweight and easy to handle for efficient field use
- Contributes to more streamlined harvesting processes

## 242 CELL VEGETABLE PROPAGATION TRAY

<b>WEIGHT</b>	1.56kgs
<b>LENGTH</b>	670mm
<b>WIDTH</b>	340mm
<b>HEIGHT</b>	60mm
<b>CAPACITY</b>	242 cells
<b>MATERIAL</b>	Polypropylene
<b>COMPOSITION</b>	Recycled or Virgin PP for Black, Virgin PP for Green
<b>COLOUR</b>	Black or Green



### FEATURES & BENEFITS

- Designed specifically for South African growers
- Octagonal cells for easy-pull plants
- Super long-life injection molded design
- Designed to replace 200 cell Styrofoam tray
- 20% more cells but similar plant spacing & cell volume
- More plants without compromising on quality
- User friendly design for lifting and carrying
- Internal root training ribs for excellent roots
- Designed for T-rail benching
- Easy to sterilize







# RETAIL

## RIGID PACKAGING

- SUPER DOLLY
- PICKING TOTE
- NESTABLE TOTE BINS 7L
- NESTABLE TOTE BINS 18L
- NESTABLE TOTE BINS 52L
- NESTABLE TOTE BINS 68L

# RIGID PACKAGING

## SUPER DOLLY

<b>WEIGHT</b> <small>(WITHOUT CASTORS)</small>	4.2kg
<b>LENGTH</b> <small>(WITHOUT CASTORS)</small>	600mm
<b>WIDTH</b> <small>(WITHOUT CASTORS)</small>	800mm
<b>HEIGHT</b> <small>(WITHOUT CASTORS)</small>	70,5mm
<b>MATERIAL</b>	Polypropylene
<b>CASTORS</b>	100mm (Fixed/ Swivel/Swivel Brake)
<b>DRAINAGE</b>	Yes
<b>LOAD CAPACITY</b>	500kg



### FEATURES & BENEFITS

- The plastic dolly is stackable for easy storage and ideal for ambient or chilled environments, especially in perishable supply chains
- 100% Recyclable
- Customisable non-slip load surface gromets
- Interconnecting handles
- Ergonomic grips
- Strapping apertures on long- and short-side leading
- Additional securing bar at the bottom for additional support

## PICKING TOTE

<b>WEIGHT</b>	2.5kg
<b>LENGTH</b> <small>(EXTERNAL)</small>	600mm
<b>WIDTH</b> <small>(EXTERNAL)</small>	450mm
<b>HEIGHT</b> <small>(EXTERNAL)</small>	400mm
<b>MATERIAL</b>	Polypropylene
<b>WALL THICKNESS</b>	3.0mm
<b>LOAD CAPACITY</b>	25kg



### FEATURES & BENEFITS

- Fully compatible with conveyor and shuttle systems, making it an ideal for high-speed automated picking environments.
- Vertical sides and ends maximise space and allow stable stacking
- External ribs on both sides for printed label placement
- 3.0mm thick walls and base ensure lasting load-bearing performance
- Available with RFID and/or Barcode

## NESTABLE TOTE BINS 7L

<b>WEIGHT</b>	1.8kg
<b>LENGTH</b>	300mm
<b>WIDTH</b>	200mm
<b>HEIGHT</b>	185mm
<b>MATERIAL</b>	Virgin or Recycled Polypropylene
<b>LOAD CAPACITY</b>	18kg
<b>COLOUR</b>	Customisable



### FEATURES & BENEFITS

- Textured base for stable stacking, nesting and conveyor use
- Interchangeable and replaceable lids
- 100% Recyclable
- Tamperproof via two locking holes and optional thumb security seals
- Available with RFID and/or Barcode

# RIGID PACKAGING

**FEATURES & BENEFITS**

- Textured base for stable stacking, nesting and conveyor use
- Interchangeable and replaceable lids
- 100% Recyclable
- Tamperproof via two locking holes and optional thumb security seals
- Available with RFID and/or Barcode



**NESTABLE TOTE BINS 18L**

<b>WEIGHT</b>	2.8kg
<b>LENGTH</b>	400mm
<b>WIDTH</b>	300mm
<b>HEIGHT</b>	240mm
<b>MATERIAL</b>	Virgin or Recycled Polypropylene
<b>LOAD CAPACITY</b>	30kg
<b>COLOUR</b>	Customisable

**FEATURES & BENEFITS**

- Textured base for stable stacking, nesting and conveyor use
- Interchangeable and replaceable lids
- 100% Recyclable
- Tamperproof via two locking holes and optional thumb security seals
- Available with RFID and/or Barcode



**NESTABLE TOTE BINS 52L**

<b>WEIGHT</b>	3.06kg
<b>LENGTH</b>	600mm
<b>WIDTH</b>	400mm
<b>HEIGHT</b>	320mm
<b>MATERIAL</b>	Virgin or Recycled Polypropylene
<b>LOAD CAPACITY</b>	35kg
<b>COLOUR</b>	Customisable

**FEATURES & BENEFITS**

- Textured base for stable stacking, nesting and conveyor use
- Interchangeable and replaceable lids
- 100% Recyclable
- Tamperproof via two locking holes and optional thumb security seals
- Available with RFID and/or Barcode



**NESTABLE TOTE BINS 68L**

<b>WEIGHT</b>	3.3kg
<b>LENGTH</b>	600mm
<b>WIDTH</b>	400mm
<b>HEIGHT</b>	365mm
<b>MATERIAL</b>	Virgin or Recycled Polypropylene
<b>LOAD CAPACITY</b>	35kg
<b>COLOUR</b>	Customisable





Stanton Global is focused on product development, tooling design and innovation, supporting businesses from concept through to production-ready solutions. With strong expertise in design engineering, prototyping and tooling development, we help accelerate product development while ensuring practical, manufacturable and commercially viable outcomes.

We operate as a strategic product development partner, working closely with customers to transform ideas into engineered solutions that are technically sound and market-ready. From feasibility studies and design refinement through to prototype validation and tooling implementation, our structured approach reduces risk, improves speed to market and supports scalable production.

Our team combines industrial design insight with mechanical engineering expertise to create products that balance performance, durability and cost-efficiency. A strong focus on design for manufacture ensures solutions are optimised for tooling efficiency, material performance and long-term reliability.

## Our Core Capabilities

Stanton Global provides comprehensive development services including:

- Product concept development and feasibility assessment
- 3D CAD design and engineering refinement
- Prototyping and design validation
- Tooling design and technical support
- Material selection and performance optimisation
- Manufacturing readiness planning
- Commercialisation strategy support

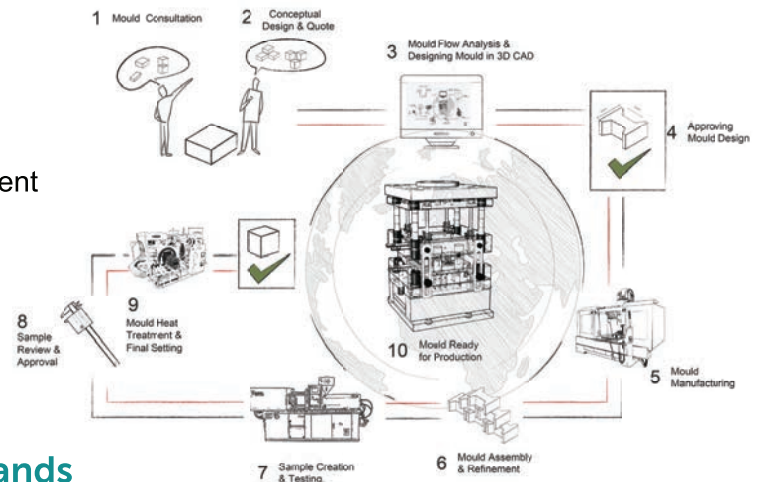

## Driving Innovation Through Specialised Brands

Through our specialised brands, Stanton Global drives innovation across multiple sectors. 7Twenty delivers advanced connectivity solutions for the fibre and telecommunications industry, Safeload focuses on transport safety and load securement products, and Pallchem provides engineered solutions for chemical processing and industrial applications. Together, these brands reflect our commitment to engineered performance, safety, reliability and market-driven innovation.

## Innovation with Commercial Focus

At Stanton Global, innovation is driven by purpose. We focus on solving real industry challenges from improving installation efficiency and safety compliance to enhancing product durability and operational performance.

By integrating design engineering, tooling expertise and market insight, Stanton Global bridges the gap between innovation and manufacture. We enable businesses to move confidently from concept to scalable production, delivering solutions that perform reliably in demanding real-world environments.



 **SAFELoad**

View our product range online: [www.safeload.biz](http://www.safeload.biz)



**DURATOUGH BOXES**



[www.safeload.biz](http://www.safeload.biz)

**MAXI PRO 500**

**MAXI PRO 700**

Safeload is a trusted provider of high-quality safety and load securement solutions designed for the transport, logistics, industrial and commercial sectors. Our products are engineered to improve safety, protect cargo and support compliance across demanding environments, helping customers operate confidently and efficiently every day.

Our range includes durable wheel chocks, wheel nut indicators, ratchets and straps, corner protectors, fire extinguisher boxes, storage toolboxes and other safety-focused transport solutions. Built for reliability and performance, Safeload products are designed to withstand tough conditions while delivering practical, long-lasting value — because when safety matters, quality makes the difference.

**MIGHTY CHOCKS**

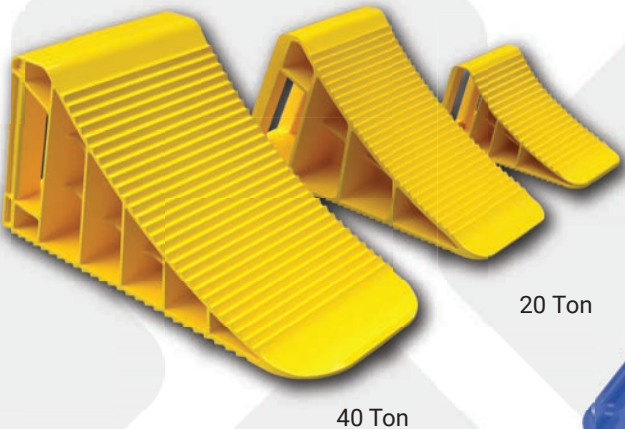

5 Ton

20 Ton

40 Ton

**RATCHET STRAPS**



**FIRE EXTINGUISHER BOXES**

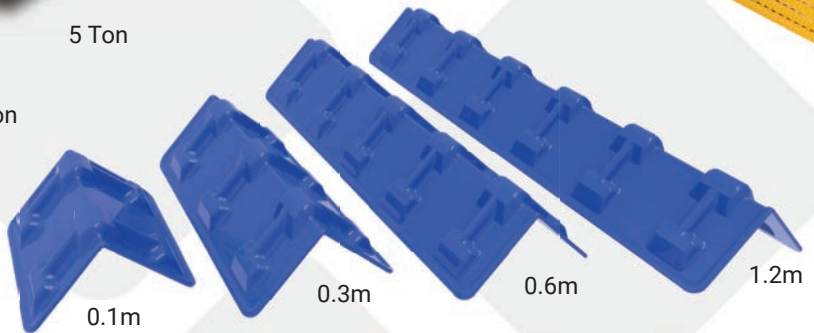

0.1m

0.3m

0.6m

1.2m

**CORNER PROTECTORS**



**WHEEL NUT INDICATORS**



 **7twenty**

View our product range online: [www.7twenty.tech](http://www.7twenty.tech)



**M32 SUBSCRIBER NODE**



[www.7twenty.tech](http://www.7twenty.tech)

7Twenty delivers innovative connectivity solutions for the fiber optic and telecommunications industries, supporting efficient network installation above and below ground. As a globally recognized partner to network operators and installers, 7Twenty focuses on practical, high-performance products that enable faster deployment, reliable connectivity and long-term network performance.

Our range includes advanced fiber enclosures, rapid-deployment connectivity solutions and custom-developed products designed to meet evolving network demands. Backed by strong design, engineering and manufacturing expertise, 7Twenty helps customers reduce total build costs, improve installation efficiency and build infrastructure that keeps people, businesses and communities connected.



**RAPID-HOLD**

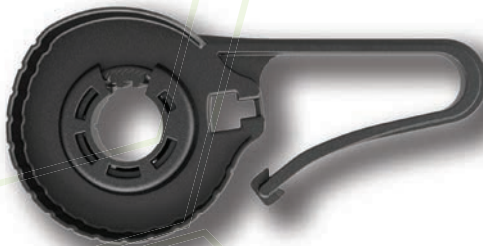

**NID BOX**



**M16 MICROLOOP**

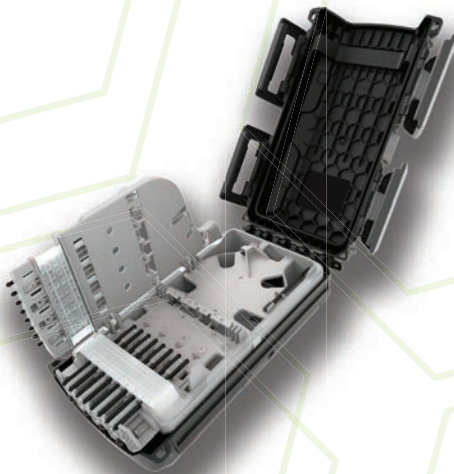

**UG300**

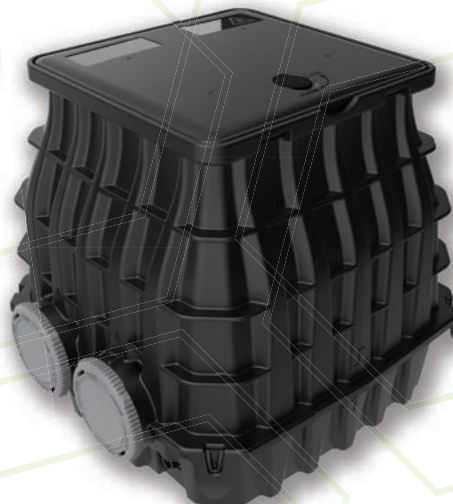

**M8 MICROLOOP**





View our product range online: [www.pallchem.co.za](http://www.pallchem.co.za)

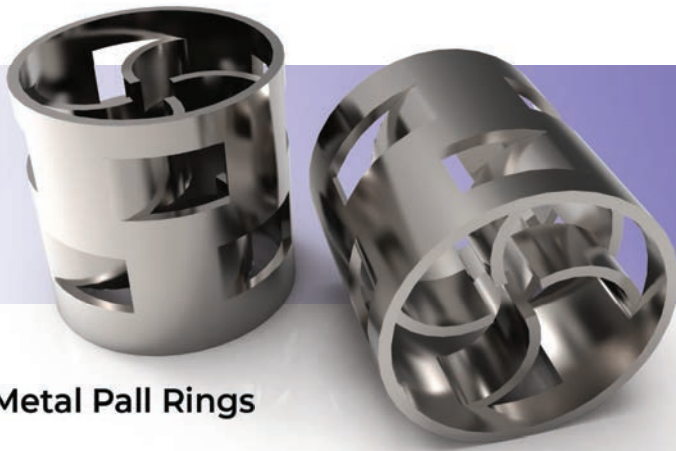

### Metal Pall Rings

Pallchem specialises in high-performance mass transfer and separation media for the chemical processing, industrial and environmental sectors. With expertise in the manufacture and supply of plastic, metal and ceramic random packings, Pallchem supports critical processes such as absorption, stripping and distillation, helping industries achieve efficient, reliable and cost-effective operations.

Our product range includes advanced tower packing solutions designed to optimise gas-liquid interaction, improve process efficiency and withstand demanding industrial environments. Engineered for durability, performance and sustainability, Pallchem solutions help customers enhance productivity, reduce operating costs and improve environmental performance across a wide range of industrial applications.

### Plastic Saddles



### Ceramic Saddles

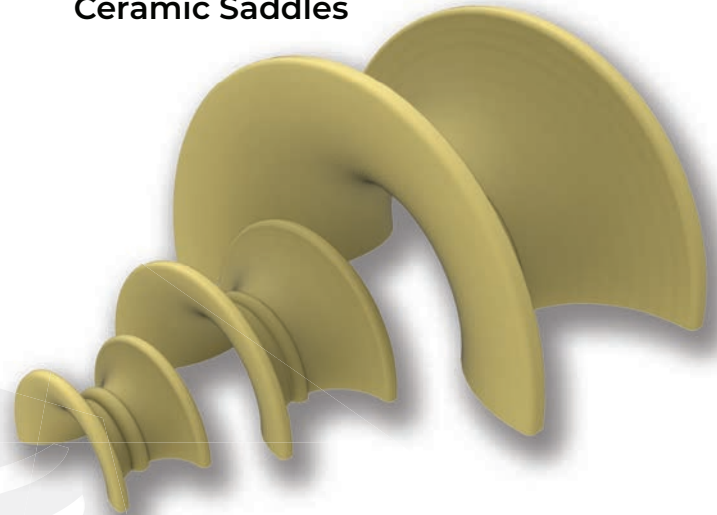

### Plastic Pall Rings

### Plastic Cascade Rings

# CONTACT US



[www.pimms.group](http://www.pimms.group)  
[info@pimms.co.za](mailto:info@pimms.co.za)



[www.tegoplastics.co.za](http://www.tegoplastics.co.za)  
[sales@tegoplastics.co.za](mailto:sales@tegoplastics.co.za)



[www.stanton.global](http://www.stanton.global)  
[info@stanton.global](mailto:info@stanton.global)



[www.safeload.biz](http://www.safeload.biz)  
[sales@safeload.co.za](mailto:sales@safeload.co.za)



[www.7twenty.tech](http://www.7twenty.tech)  
[sales@7twenty.co.za](mailto:sales@7twenty.co.za)



[www.pallchem.co.za](http://www.pallchem.co.za)  
[sales@pallchem.co.za](mailto:sales@pallchem.co.za)